











varisco[®]
solid pumping solutions





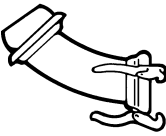
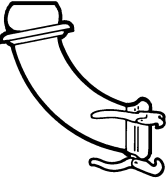



**Accessori per pompe e
impianti wellpoint**
**Accessories for pumps and
wellpoint system**
**Accessoires pour pompes et
équipements wellpoint**
**Accesorios para bombas y
instalaciones wellpoint**

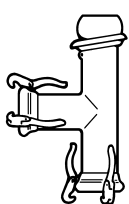



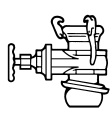
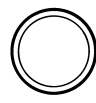
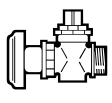

Descrizione Description Descripción	Image	Materiale Material Matériel Material	Note Notes Remarques Notas	Codice Code Code Código	Peso Weight Poids Peso [kg]	Lunghezza Length Longueur Longitud [mm]	Diametro Diameter Diamètre Diámetro [mm / in]		Connessioni Connections Connexions Conexiones [mm] [in]	
							[mm]	[in]	[mm]	[in]
N° 1 Raccordo portagomma maschio Male hose fitting Raccord mâle porte-tuyau Racor macho para manguera		Acciaio zincato Galvanized steel Acier galvanisé Acero galvanizado		10013367	0,4	110	40		50	2"
				10013368	0,6	130	50			
				10013369	0,8	140	60			
				10013371	1,3	230	80			
				10013374	1,7	280	100			
				10013376	2,8	290	120			
				10013377	3,5	295	150			
				10013379	8	355	200			
				10013380	12	400	250			
				10013381	24	505	300			
				10013349	0,8	105	40			
				10013350	1,3	140	50			
N° 2 Raccordo portagomma femmina Female hose fitting Raccord femelle porte-tuyau Racor hembra para manguera		Acciaio zincato Galvanized steel Acier galvanisé Acero galvanizado		10013351	1,4	150	60		80	3"
				10013354	1,5	225	80			
				10013357	2,0	240	80			
				10013356	2,3	250	100			
				10013359	3,0	255	120			
				10013360	3,6	260	150			
				10013363	9	300	200			
				10013365	11	340	250			
				10013366	25	440	300			
				10013311	0,3	60	1 ¼"			
				10013312	0,4	70	1 ½"			
				10013313	0,5	85	2"			
N° 3 Raccordo maschio filettato Threaded male coupling Raccord mâle fileté Racor macho roscado		Acciaio zincato Galvanized steel Acier galvanisé Acero galvanizado		10013316	1,4	145	3"		80	3"
				10013318	1,9	150	4"			
				10013324	3,0	190	5"			
				10013326	3,5	170	5"			
				10018445	3,8	180	6"			
				10013302	0,7	75	1 ¼"			
				10013301	0,9	80	1 ½"			
				10013303	1	100	2"			
				10013304	1,7	110	3"			
				10013307	2,1	115	4"			
				10013308	3,2	125	5"			
				10013310	4	140	6"			
N° 4 Raccordo femmina filettato Threaded female coupling Raccord femelle fileté Racor hembra roscado		Acciaio zincato Galvanized steel Acier galvanisé Acero galvanizado		10013303	1	100	2"		50	2"
				10013304	1,7	110	3"			
				10013307	2,1	115	4"			
				10013308	3,2	125	5"			

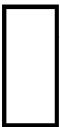
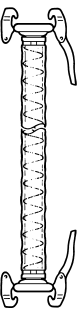
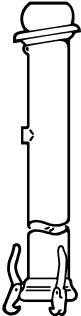
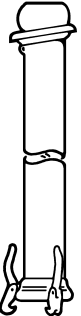

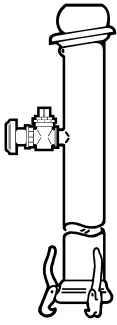
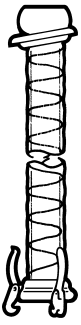
Descrizione Description Descripción	Image	Materiale Material Matériel Material	Note Notes Remarques Notas	Codice Code Code Código	Peso Weight Poids Peso [kg]	Lunghezza Length Longueur Longitud [mm]	Diametro Diameter Diamètre Diámetro [mm / in]	Connections Connexions Conexiones	
								[mm]	[in]
N° 5 Raccordo maschio flangiato Flanged male coupling Raccord mâle bridé Racor de brida macho		Acciaio zincato Galvanized steel Acier galvanisé Acero galvanizado	**EN 1092-1 PN 10/16 *Ø 150 fresato with cut avec couronne tronquée fresado	10013331	1,5	50		50	2"
				10013314	5	100		80	3"
				10013332	6	120		100	4"
				10013335	8	180			
				**10013336	10	205		150	6"
				*10013338	8	180			
				10013344	10	255		200	8"
				10013347	20	315		250	10"
				10013348	30	380		300	12"
				10013396	2,5			80	3"
N° 6 Curva a 45° 45° elbow Coude 45° Curva 45°		Acciaio zincato Galvanized steel Acier galvanisé Acero galvanizado		10013397	3,4			100	4"
				10013398	4,5			120	5"
				10013399	6			150	6"
				10013401	15			200	8"
				10013402	22			250	10"
				10013404	1,7			50	2"
				10013405	2,7		2 leve / levers 2 leviers / palacas	80	3"
				10013407	4			100	4"
				10013409	7			120	5"
				10013410	7,5			150	6"
N° 7 Curva a 90° 90° elbow Coude 90° Curva 90°		Acciaio zincato Galvanized steel Acier galvanisé Acero galvanizado		10022355	16			200	8"
				10047781	24		3 leve / levers 3 leviers / palacas	250	10"
				10013419	42			300	12"
				10013462	1,4			100	4"
				10013463	2			120	5"
				10013464	2,9			150	6"
				10013465	7			200	8"
				10021960	11			250	10"
				10013455	0,3			50	2"
				10013457	1,4			100	4"
N° 8 Tappo maschio Male cap Bouchon mâle Tapón macho		Acciaio zincato Galvanized steel Acier galvanisé Acero galvanizado		10013458	1,9			120	5"
				10013459	2,3			150	6"
				10013460	7			200	8"
				10021959	11			250	10"
				10013455	0,3			50	2"
				10013457	1,4			100	4"
				10013458	1,9			120	5"
				10013459	2,3			150	6"
				10013460	7			200	8"
				10021959	11			250	10"
N° 9 Tappo femmina Female cap Bouchon femelle Tapón hembra		Acciaio zincato Galvanized steel Acier galvanisé Acero galvanizado		10002383	0,2			32	1 1/4"
				10002383	0,2			32	1 1/4"
				10002383	0,2			32	1 1/4"
				10002383	0,2			32	1 1/4"
				10002383	0,2			32	1 1/4"
				10002383	0,2			32	1 1/4"
				10002383	0,2			32	1 1/4"
				10002383	0,2			32	1 1/4"
				10002383	0,2			32	1 1/4"
				10002383	0,2			32	1 1/4"
N° 10 Tappo filettato / Threaded plug Bouchon fileté / Tapón roscado		Acciaio zincato Galvanized steel Acier galvanisé Acero galvanizado		10002383	0,2			32	1 1/4"
				10002383	0,2			32	1 1/4"
				10002383	0,2			32	1 1/4"
				10002383	0,2			32	1 1/4"
				10002383	0,2			32	1 1/4"
				10002383	0,2			32	1 1/4"
				10002383	0,2			32	1 1/4"
				10002383	0,2			32	1 1/4"
				10002383	0,2			32	1 1/4"
				10002383	0,2			32	1 1/4"

Descrizione Description Description	Immagine	Materiale Material Matériel Material	Note Notes Remarques Notas	Codice Code Code Código	Peso Weight Poids Peso	Lunghezza Length Longueur Longitud	Diametro Diameter Diamètre Diámetro	Connesioni Connections Connexions Conexiões	
								[mm]	[in]
N° 11 Raccordo a "T" femmina/femmina/maschio Female/female/male "T" fitting Raccord a "T" femelle/femelle/mâle Racor "T" hembra/hembra/macho		Acciaio zincato Galvanized steel Acier galvanisé Acero galvanizado		10013449	6,5			100	4"
				10013450	8			120	5"
				10013452	10	-		150	6"
				10013453	26			200	8"
				10013454	32			250	10"
N° 12 Raccordo inversione maschio/maschio Male/male inverter coupling Raccord inversion mâle/mâle Racor inversión macho/macho		Acciaio zincato Galvanized steel Acier galvanisé Acero galvanizado		10013422	1			50	2"
				10013424	2,2			100	4"
				10018441	3,4	-		120	5"
				10013425	4,5			150	6"
				10013426	1,3			50	2"
N° 13 Raccordo inversione femmina/femmina Female/female inverter coupling Raccord inversion femelle/femelle Racor inversión hembra/hembra		Acciaio zincato Galvanized steel Acier galvanisé Acero galvanizado		10013428	3,3			100	4"
				10013429	4	-		120	5"
				10013430	5			150	6"
				10013434	3,5			100	4"
				10013435	4,8			120	5"
N° 14 Riduzione maschio/femmina Male/female reducer Raccord reducteur mâle/femelle Reducción macho/hembra		Acciaio zincato Galvanized steel Acier galvanisé Acero galvanizado		10013436	5,5		100	150	6"
				10013437	5,5		120	150	6"
				10018442	8		150	200	8"
				10018444	13		150	250	10"
				10013431	3,6		100	80	3"
N° 15 Saracinesca maschio/femmina Male/female gate valve / Vanne mâle/femelle Válvula de compuerta macho/hembra		Acciaio zincato Galvanized steel Acier galvanisé Acero galvanizado		10013432	4,9		120	100	4"
				10013439	5,5		150	100	4"
				10013433	5,5		120	120	5"
				10013684	5,5		80	80	3"
				10016741	9		100	100	4"
N° 16 Guarnizione O- ring Joint Junta tórica		Gomma NBR NBR rubber Caoutchouc NBR Caucho NBR		10013685	10			120	5"
				10018447	14			150	6"
				10013049	0,02			50	2"
				10013051	0,05			80	3"
				10013052	0,07			100	4"
N° 17 Presca completa / Cock assembly Robinet complet / Grifo completo		Ottone / Brass Laiton / Latón		10013053	0,1			120	5"
				10013054	0,15			150	6"
				10013056	0,28			200	8"
				10013057	0,47			250	10"
				10013058	0,67			300	12"
10013660	1,5			32	1 1/4"				

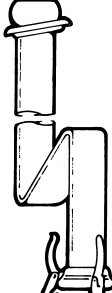
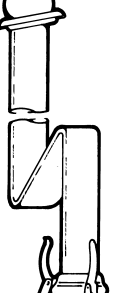

Descrizione Description Description Descripción	Descrizione Description Description Descripción	Material Material Matériel Material	Note Notes Remarques Notas	Codice Code Code Código	Peso Weight Poids Peso [kg]	Lunghezza Length Longueur Longitud [m]	Connessioni Connections Connexions Conexiones [mm]	Connessioni Connections Connexions Conexiones [in]						
N° 18 Manicotto curvo / Elbow coupling Manchon courbe / Manguito curvo		Acciaio zincato Galvanized steel Acier galvanisé Acero galvanizado		10013663	0,6	-	32	1 ¼"						
N° 19 Tubo di sollevamento / Riser pipe Tuyau de souèvement / Tubo de elevación		Acciaio zincato Galvanized steel Acier galvanisé Acero galvanizado		10013687	2,5	1	32	1 ¼"						
				10013688	5	2								
				10013689	7,5	3								
				10013690	10	4								
				10013691	12,5	5								
				10013692	15	6								
N° 20 Manicotto / Coupling sleeve Manchon / Manguito		Acciaio / Steel Acier / Acero		10013255	0,25	-	32	1 ¼"						
N° 22 Manicotto Trasflex femmina/femmina Femake/female Trasflex hose coupling Manchon Trasflex femelle/femelle Manguito Trasflex hembra/hembra		PVC	Vuoto max Max vacuum Vide max Vacío max	10013666	2,9	1	40	1 ½"						
				10019262	9	4,0	80	3"						
				10013470	11	5,8								
				10048925	12	6,2								
				10013473	12	4,0								
				10013474	16	5,8								
				10048926	17	6,2								
				10018448	15,5	4,0								
				10013477	21	5,8								
				10048927	22,5	6,2								
				10013480	16	3,0			150	6"				
				10013478	21,5	4,0								
10013479	29,5	5,8												
10048928	32	6,3												
10013481	44	4,0												
10013482	59	5,8												
10048929	63	6,3												
10016773	66	4,0												
10013483	90	5,8												
10048930	98	6,4												
10013485	80	4,0												
10013486	100	5,8												
10048931	109	6,5												
10018689	12	5,8	200	8"										
10048936	13	6,2												
10013216	16,5	4,0												
10013219	22,5	4,0												
10051209	18,0	5,8												
10051211	19,0	6,2												
10013217	22,5	5,8												
10013220	32	5,8												
10048934	24	6,2												
10048935	33	6,3												
N° 24 Collettore con attacchi Header pipe with threaded holes Tuyau collecteur avec prises pour robinet Collector con conexiones		Acciaio zincato Galvanized steel Acier galvanisé Acero galvanizado			N° 3 - 1 ¼"	10018689	12	5,8	100	4"				
						10048936	13	6,2						
			10013216	16,5		4,0								
			10013219	22,5		4,0								
			10051209	18,0		5,8								
			10051211	19,0		6,2								
			10013217	22,5		5,8								
			10013220	32		5,8								
			10048934	24		6,2								
			10048935	33		6,3								
			N° 23 Tubo di scarico Discharge pipe Tuyau de refoulement Tubo de descarga			Acciaio zincato Galvanized steel Acier galvanisé Acero galvanizado	N° 6 - 1 ¼"	10018689			12	5,8	300	12"
								10048936			13	6,2		
10013216	16,5	4,0												
10013219	22,5	4,0												
10051209	18,0	5,8												
10051211	19,0	6,2												
10013217	22,5	5,8												
10013220	32	5,8												
10048934	24	6,2												
10048935	33	6,3												

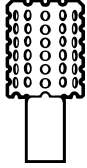
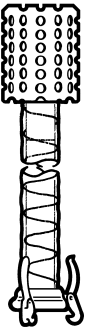
Descrizione Description Description Descripción	Immagine	Materiale Material Matériel Material	Note Notes Remarques Notas	Codice Code Code Código	Peso Weight Poids Peso [kg]	Lunghezza Length Longueur Longitud [m]	Connessioni Connections Connexions Conexiones	
							[mm]	[in]
N° 25 Collettore con prese complete Header pipe complete with cock assemblies Tuyau collecteur avec robinets Colector con grifos completos		Acciaio zincato Galvanized steel Acier galvanisé Acero galvanizado	N° 3 - 1 1/4" N° 6 - 1 1/4" N° 3 - 1 1/4" N° 4 - 1 1/4" N° 6 - 1 1/4" N° 3 - 1 1/4" N° 4 - 1 1/4" N° 6 - 1 1/4"	10018691	16,5	5,8	100	4"
				10048941	17,5	6,2	100	4"
				10051210	24,0	5,8	100	4"
				10051212	25,0	6,2	100	4"
				10013654	21	4,0	120	5"
				10018449	28,5	5,8	120	5"
				10048940	30	6,2	120	5"
				10013655	31,5	5,8	120	5"
				10048937	33	6,2	120	5"
				10013657	27	4,0	150	6"
N° 26 Tubo flessibile (PVC con spirale in acciaio) Flexible hose (PVC with steel spiral) Tuyau flexible (PVC avec spire d'acier) Tubo flexible (PVC con espiral de acero)		PVC	Vuoto max Max vacuum Vide max Vacío max	10013539	9,5	4	50	2"
				10013540	12,5	6	50	2"
				10013541	18	10	50	2"
				10013549	9	2	80	3"
				10013550	17	4	80	3"
				10013551	19,5	5	80	3"
				10013552	23	6	80	3"
				10013561	53	2	100	4"
				10013563	22	4	100	4"
				10013564	26	5	100	4"
10013565	30	6	100	4"				
10015784	10	10	120	5"				
N° 28 Tubo flessibile (Gomma / tela con spirale in acciaio) Flexible hose (Rubber / canvas with steel spiral) Tuyau flexible (Caoutchouc/toile avec spire d'acier) Tubo flexible (Caucho / tela con espiral de acero)		Gomma / tela Rubber / canvas Caoutchouc / toile Caucho / tela	Vuoto max Max vacuum Vide max Vacío max	10013570	16,5	2	120	5"
				10013572	20	3	120	5"
				10013571	27	4	120	5"
				10018452	38,5	6	120	5"
				10013573	22,5	2	150	6"
				10013580	29,5	3	150	6"
				10013575	39	4	150	6"
				10013576	47,5	5	150	6"
				10013577	55	6	150	6"
				10013581	42	2	200	8"
10013582	67	4	200	8"				
10018460	79	5	200	8"				
10013583	92	6	200	8"				
10013585	64	2	250	10"				
10016001	77	3	250	10"				
10013586	103	4	250	10"				
10013587	124	5	250	10"				
10013588	153	6	250	10"				
10013591	75	2	300	12"				
10018811	112,5	3	300	12"				
10013592	150	4	300	12"				

Descrizione Description Descripción	Image	Materiale Material Matériel Material	Note Notes Remarques Notas	Codice Code Code Código	Peso Weight Poids Peso	Lunghezza Length Longueur Longitud	Pressione Pressure Pression Presión	Connesioni Connections Connexions Conexiones	
								[mm]	[in]
N° 29 Manichetta di mandata Flat discharge hose Tuyau de refoulement Manguera de descarga		PVC / tela PVC / canvas PVC / toile PVC / tela		10012918	0,32/m		8	40	1 ½"
				10012919	0,41/m		10	50	2"
				10012920	0,56/m		8	60	2 ½"
				10012921	0,77/m		8	80	3"
				10012922	1,05/m		8	100	4"
				10012923	1,28/m		6	127	5"
				10012924	1,60/m		4	150	6"
				10012925	2,40/m		2,5	204	8"
				10012926	1,30/m	Gomma / tela Rubber / canvas Caoutchouc / toile Caucho / tela	5	250	10"
				10012927	2,10/m		5	300	12"
N° 30 Manichetta di mandata con raccordo femmina Flat discharge hose with female coupling Tuyau de refoulement avec raccord femelle Manguera de descarga con racor hembra		PVC / tela PVC / canvas PVC / toile PVC / tela		10013597	4,3	10	10	40	1 ½"
				10018651	7,5	10	10	50	2"
				10013606	9	10	8	80	3"
				10013611	11	10	4	100	4"
				10018652	14	10	6	127	5"
				10015378	23,5	10	4	150	6"
				10015399	28	10	2,5	204	8"
				10018653	39,5	Gomma / tela Rubber / canvas Caoutchouc / toile Caucho / tela	5	250	10"
				10018654	76		5	300	12"
				10013620	5,5		8	40	1 ½"
N° 31 Manichetta di mandata con raccordi maschio/femmina Flat discharge hose with male/female couplings Tuyau de refoulement avec raccords mâle/femelle Manguera de descarga con racores macho/hembra		PVC / tela PVC / canvas PVC / toile PVC / tela	2 leve / levers 2 leviers / palacas 3 leve / levers 3 leviers / palacas	10013621	8	10	10	50	2"
				10013623	8	10	16		
				10013631	11,5	10	8	80	3"
				10013638	14,5		8	100	4"
				10013637	15		8		
				10018317	18		6	127	5"
				10013648	23		4	150	6"
				10013653	41		2,5	204	8"
				10013590	64	Gomma / tela Rubber / canvas Caoutchouc / toile Caucho / tela	5	250	10"
				10013593	168		5	300	12"
N° 31.1 Manichetta di infissione con raccordi maschio/femmina Jetting hose with male/female couplings Tuyau de lançage avec raccords mâle/femelle Manguera hincado con racores macho/hembra		Gomma / tela Rubber / canvas Caoutchouc / toile Caucho / tela		10018699	11	10	10	50	2"

Descrizione Description Description Descripción	Immagine	Materiale Material Matériel Material	Note Notes Remarques Notas	Codice Code Code Código	Peso Weight Poids Peso [kg]	Lunghezza Length Longueur Longitud [m]	Conessioni Connections Connexions Conexiones	
							[mm]	[in]
N° 32 Filtro di fondo Strainer Crépine Filtro de fondo		Acciaio zincato Galvanized steel Acier galvanisé Acero galvanizado		10013242	0,67	0,200	40	1 ½"
				10013243	0,95	0,240	50	2"
				10013246	1,95	0,320	80	3"
				10013247	2,87	0,440	100	4"
				10013248	4,5	0,550	120	5"
				10013249	8	0,640	150	6"
				10013252	15,5	0,810	200	8"
				10013227	1,7	0,210	50	2"
				10013228	2,8	0,320	80	3"
				10013229	5	0,450	100	4"
				10013230	7,5	0,610	120	5"
				10013231	10,5	0,700	150	6"
				10013234	22	0,910	200	8"
10013235	90	1,190	250	10"				
10013237	140	1,840	300	12"				
N° 34 Tubo di aspirazione flessibile con filtro (PVC con spirale in acciaio) Flexible suction hose with strainer (PVC with steel spiral) Tuyau flexible d'aspiration avec crépine (PVC avec spire d'acier) Tubo de aspiración flexible con filtro (PVC con espiral de acero)		PVC + Acciaio zincato PVC + Galvanized steel PVC + Acier galvanisé PVC + Acero galvanizado		10013495	9,5	4	50	2"
				10013496	11	6	60	2 ½"
				10013497	12,5	6	80	3"
				10013503	15	6	100	4"
				10013506	17,5	6	120	5"
				10013507	20,5	6	150	6"
				10013508	24	6	200	8"
				10013520	22,5	6	250	10"
				10013521	26,5	6	300	12"
				10013522	31	6	400	16"
				10017849	30	4	120	5"
				10015729	38	6	150	6"
				10013530	28	2	80	3"
10029782	30	3	100	4"				
10013529	44	4	120	5"				
10013527	52	5	150	6"				
10013528	60	6	200	8"				
10013534	73,5	4	300	12"				
10013535	99,5	6	400	16"				
N° 37 Punta filtrante (telaio in alluminio, guaina filtrante inox reps) Wellpoint spear (aluminium frame, reps stainless steel screen) Pointe filtrante (châssis en aluminium, gaine filtrante en acier inox reps) Punta de filtración (bastidor de aluminio, vaina de filtración inoxidable reps)		Alluminio + Acciaio inox Aluminium + Stainless steel Aluminium + Acier inoxydable Aluminio + Acero inoxidable		10013671	1,7	0,650	32	1 ¼"

Descrizione Description Description	Immagine	Materiale Material Matériel Material	Note Notes Remarques Notas	Codice Code Code Código	Peso Weight Poids Peso [kg]	Lunghezza Length Longueur Longitud [m]	Conessioni Connections Connexions Conexiones	
							[mm]	[in]
N° 39 Punta filtrante per ghiaia Wellpoint spear for gravel Pointe filtrante pour gravillon Punta de filtración para gravilla		Alluminio Aluminium Aluminium Alumínio		10013682	1,7	0,350	32	1 ¼"
N° 44 Tubo di sollevamento + punta filtrante (Ref. 37) Riser pipe + wellpoint spear (Ref. 37) Tuyau de soulèvement + pointe filtrante (Ref. 37) Tubo de elevación + punta de filtración (Ref. 37)		Alluminio + Acciaio Aluminium + Steel Aluminium + Acier Alumínio + Acero		10013680	10	3	32	1 ¼"
				10013681	12,5	4		
				10018701	15	5		
				10017024	17,5	6		
N° 45 Tubo di sollevamento + punta filtrante per ghiaia Riser pipe + wellpoint spear for gravel Tuyau de soulèvement + pointe filtrante pour gravillon Tubo de elevación + punta de filtración para gravilla		Alluminio + Acciaio Aluminium + Steel Aluminium + Acier Alumínio + Acero		10016932	10	3	32	1 ¼"
				10016798	12,5	4		
				10013683	15	5		
				10018669	17,5	6		
N° 46 Tubo di sollevamento Riser pipe Tuyau de soulèvement Tubo de elevación		PVC		10045490	3	2	32	1 ¼"
				10045491	4,5	3		
				10045492	5,5	4		
				10045493	7	5		
				10045494	8	6		
				10045226	3	2		
N° 47 Tubo di sollevamento con gomito Riser pipe with elbow Tuyau de soulèvement avec coude Tubo de elevación con codo		PVC		10045225	4	3	32	1 ¼"
				10044480	5	4		
				10044479	6,5	5		
				10044481	9	6		
				10045226	3	2		
N° 48 Punta filtrante / Wellpoint spear Pointe filtrante / Punta de filtración		PVC + PE HD		10044478	0,7	-	32	1 ¼"
				10045224	3,4	2		
N° 49 Tubo di sollevamento con gomito e punta filtrante Riser pipe with elbow and wellpoint spear Tuyau de soulèvement avec coude et pointe filtrante Tubo de elevación con codo y punta de filtración		PVC + PE HD		10045223	4,6	3	32	1 ¼"
				10044483	6	4		
				10044482	7	5		
				10044484	8,5	6		

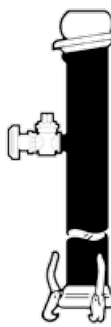
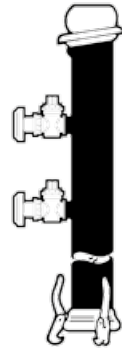
Descrizione Description Descripción	Disegno Drawing	Materiale Material Matériel Material	Note Notes Remarques Notas	Codice Code Code Código	Peso Weight Poids Peso [kg]	Lunghezza Length Longueur Longitud [m]	Connessioni Connections Connexions Conexiones	
							[mm]	[in]
N° 50 Tubo di scarico con raccordi Discharge pipe with couplings Tuyau de refoulement avec raccords Tubo de descarga con racores		PE HD		10045076	10	3,0	100	4"
				10045075	12	4,0	100	4"
				10045074	16	5,8	100	4"
				10045236	12,5	4,0	120	5"
				10045237	15,5	5,8	120	5"
				10045238	18,5	4,0	150	6"
10045239	26	5,8	150	6"				
N° 51 Collettore con 3 attacchi Header pipe with 3 threaded holes Tuyau collecteur avec 3 prises pour robinet Colector con 3 conexiones		PE HD	N° 3 - 1 1/4"	10044487	6,5	5,8	100	4"
				10045241	10,5	4,0	120	5"
				10045242	17	4,0	150	6"
N° 52 Collettore con 6 attacchi Header pipe with 6 threaded holes Tuyau collecteur avec 6 prises pour robinet Colector con 6 conexiones		PE HD	N° 6 - 1 1/4"	10044486	17,5	5,8	120	5"
				10044485	27,5	5,8	150	6"
N° 53 Collettore con 3 prese complete Header pipe with 3 cock assemblies Tuyau collecteur avec 3 robinets Colector con 3 grifos completos		PE HD	N° 3 - 1 1/4"	10044488	10	5,8	100	4"
				10045245	15	4,0	120	5"
				10045246	21	4,0	150	6"
N° 54 Collettore con 6 prese complete Header pipe with 6 cock assemblies Tuyau collecteur avec 6 robinets Colector con 6 grifos completos		PE HD	N° 6 - 1 1/4"	10044489	25	5,8	120	5"
				10044490	33	5,8	150	6"

ACCESSORI STANDARD PER POMPE / STANDARD PUMP ACCESSORIES
ACCESSOIRES STANDARD POUR POMPES / ACCESORIOS ESTÁNDARES PARA BOMBAS

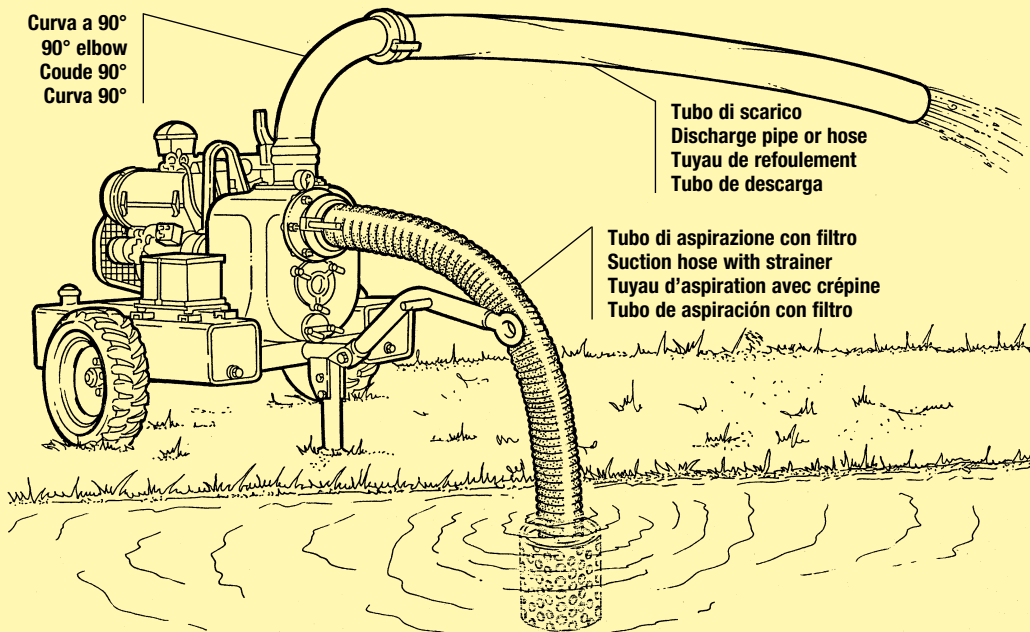

IMPIANTO WELLPOINT STANDARD / STANDARD WELLPOINT SYSTEM
ÉQUIPEMENT WELLPOINT DE SÉRIE / INSTALACIÓN WELLPOINT ESTÁNDAR

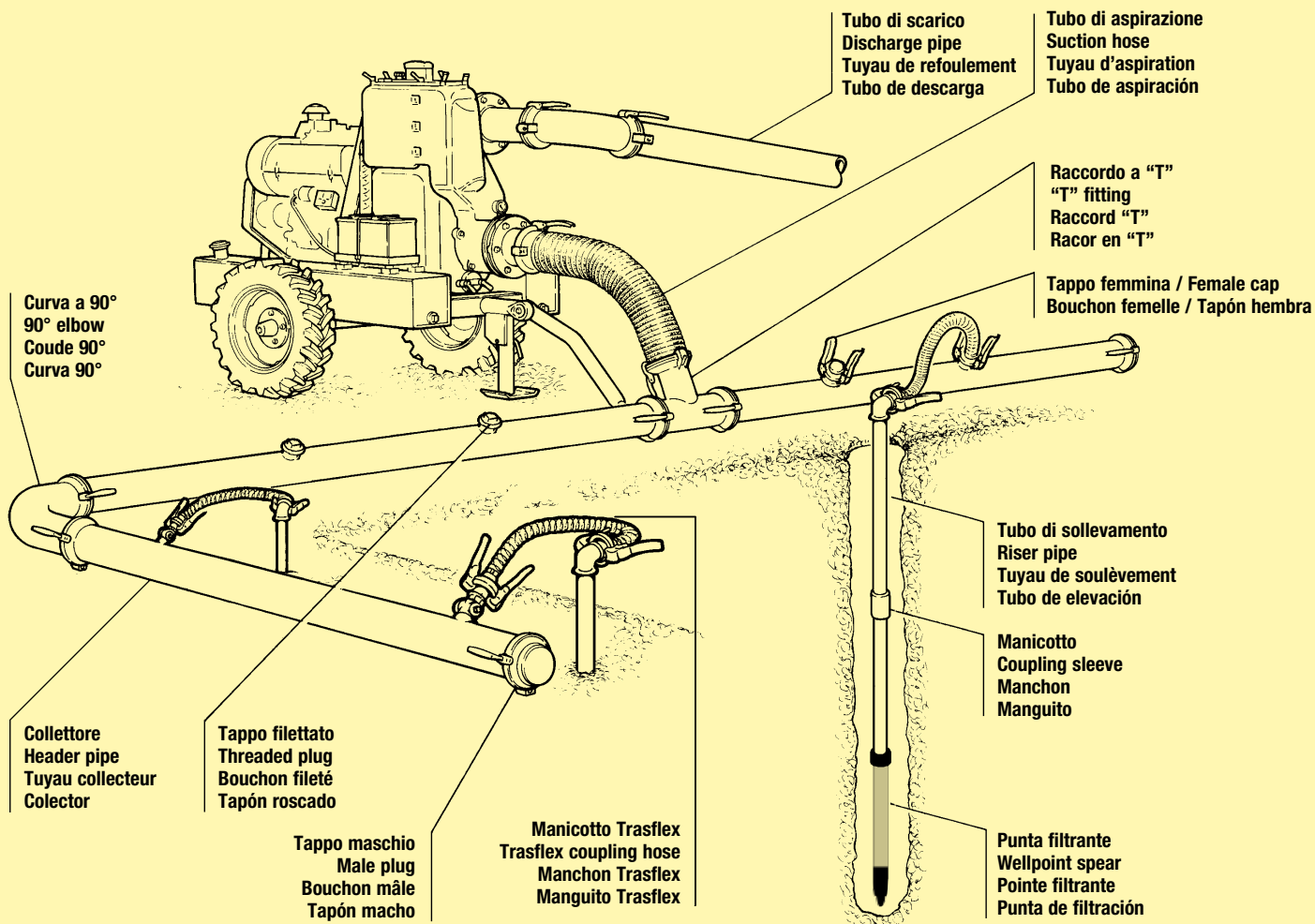

VARISCO S.p.A.

variscospa.com

**Terza Strada, 9 - Z.I. Nord
35129 PADOVA - Italy
Tel. +39 049 82 94 111
Fax +39 049 82 94 373**

**Vendite Italia
Tel. 049 82 94 111
Fax 049 82 94 373
italia@variscospa.com**

**International sales
Tel. +39 049 82 94 111
Fax +39 049 80 76 762
export@variscospa.com**

**EN ISO 9001 : 2008
Reg. No. 44 100 091767**

